

PRZEKROJE POPRZECZNE DROGI WOJEWÓDZKIEJ NR 651 OD KM 89+925 DO KM 90+332

SKALA 1:10/100

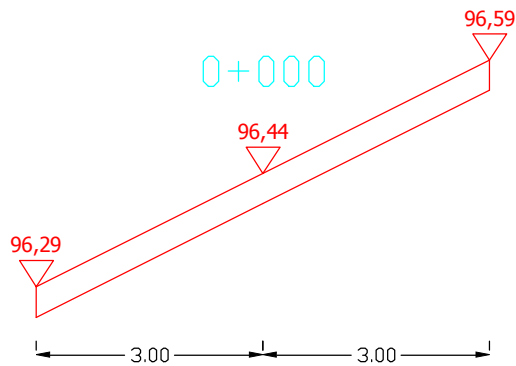

Pwyr.=0,0000 m²

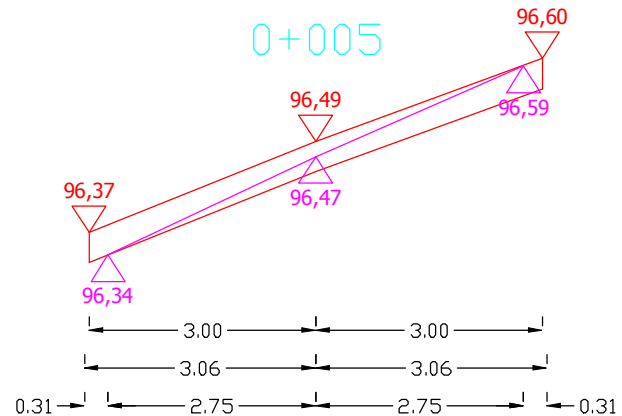

Pwyr.=0,0000 m²

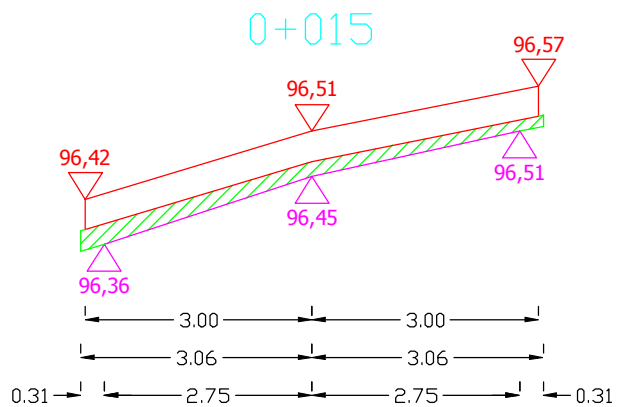

Pwyr.=0,1266 m²

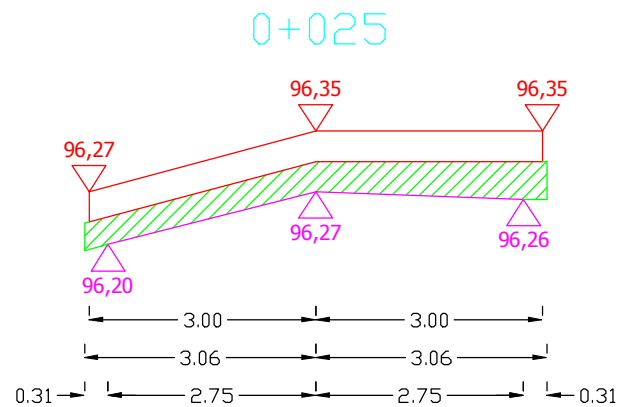

Pwyr.=0,2560 m²

Sporządził:

PRZEKROJE POPRZECZNE DROGI WOJEWÓDZKIEJ NR 651 OD KM 89+925 DO KM 90+332

SKALA 1:10/100

0+035

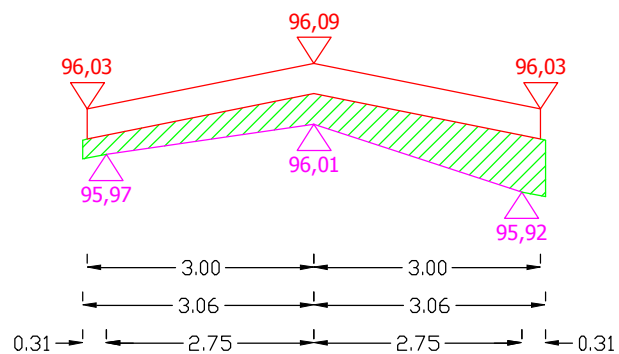

Pwyr.=0,2785 m²

0+045

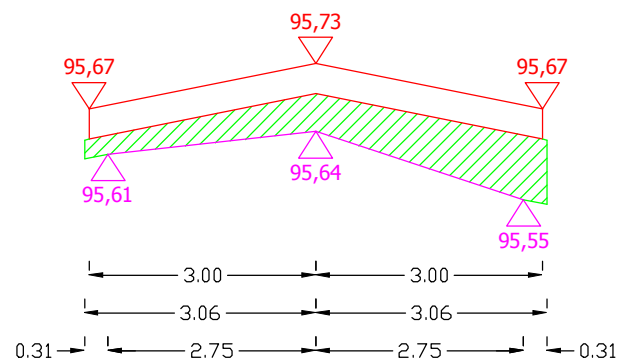

Pwyr.=0,3229 m²

0+055

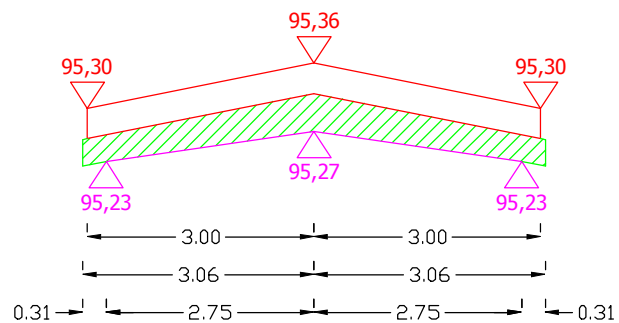

Pwyr.=0,2555 m²

0+065

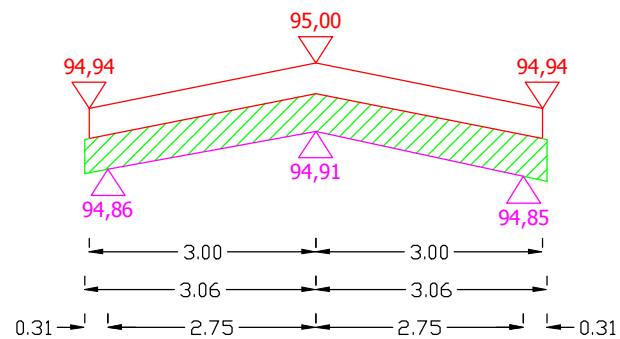

Pwyr.=0,3060 m²

Sporządził:

PRZEKROJE POPRZECZNE DROGI WOJEWÓDZKIEJ NR 651 OD KM 89+925 DO KM 90+332

SKALA 1:10/100

0+075

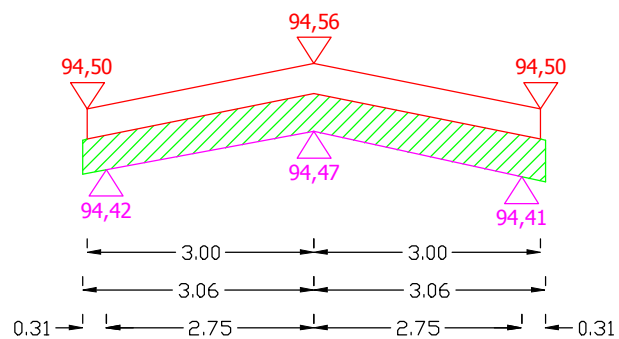

Pwyr.=0,3060 m²

0+085

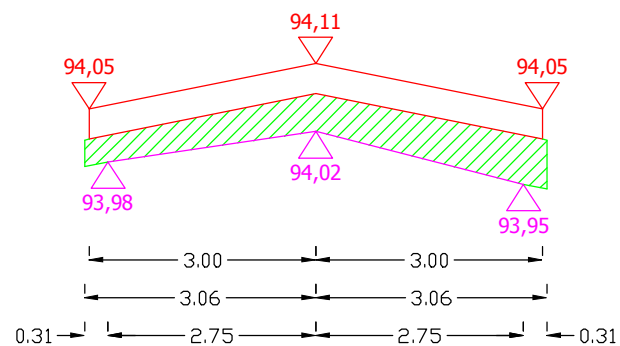

Pwyr.=0,3060 m²

0+095

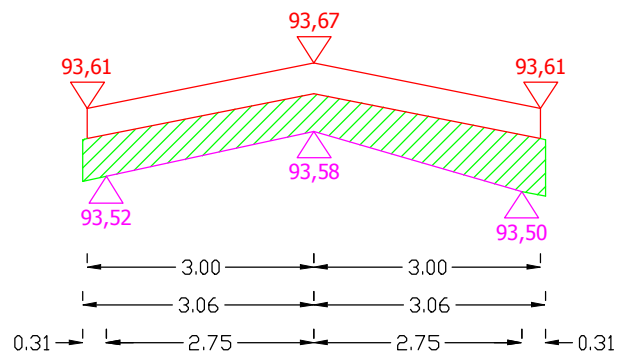

Pwyr.=0,3566 m²

0+105

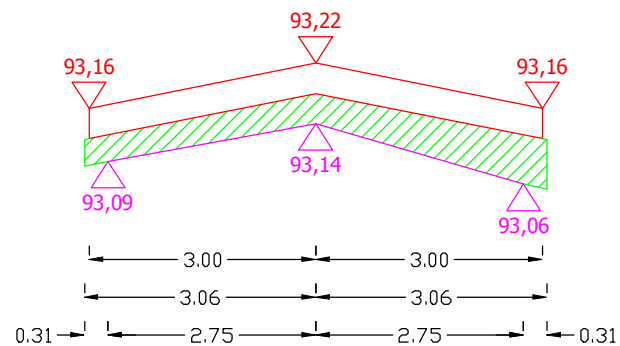

Pwyr.=0,2785 m²

Sporządził:

PRZEKROJE POPRZECZNE DROGI WOJEWÓDZKIEJ NR 651 OD KM 89+925 DO KM 90+332

SKALA 1:10/100

0+115

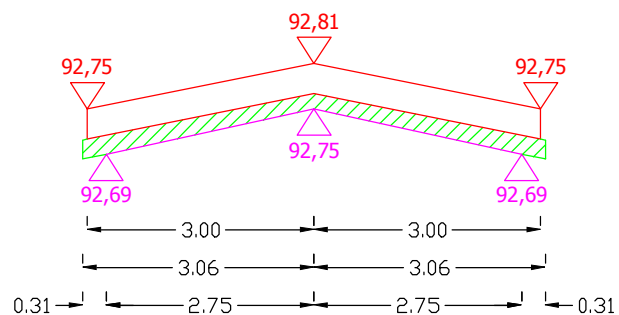

Pwyr.=0,1393 m²

0+125

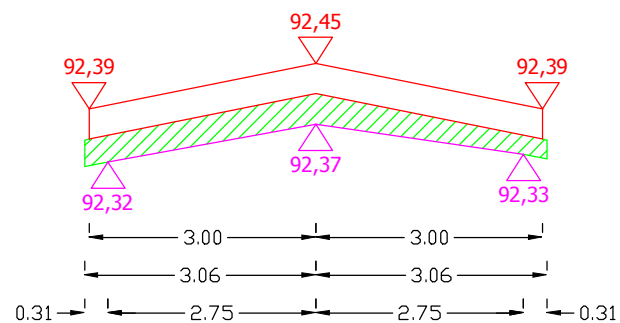

Pwyr.=0,2111 m²

0+135

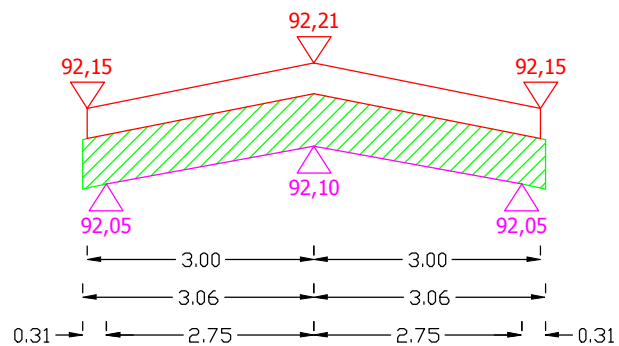

Pwyr.=0,4116 m²

0+145

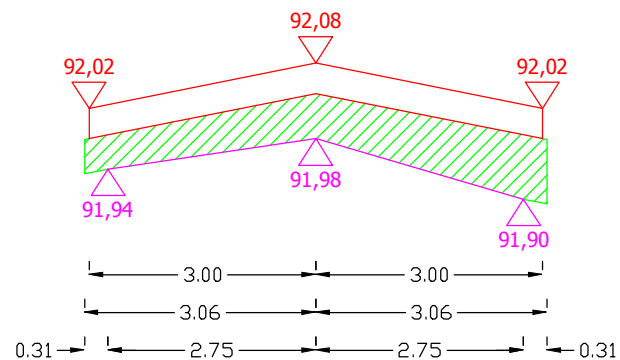

Pwyr.=0,3841 m²

Sporządził:

PRZEKROJE POPRZECZNE DROGI WOJEWÓDZKIEJ NR 651 OD KM 89+925 DO KM 90+332

SKALA 1:10/100

0+155

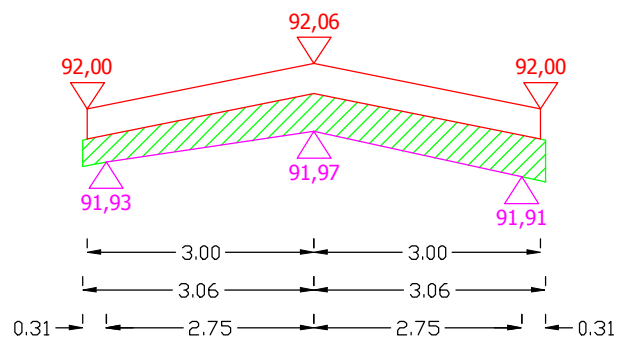

Pwyr.=0,2892 m²

0+165

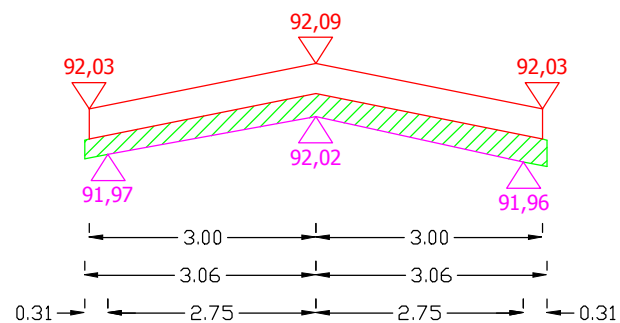

Pwyr.=0,1836 m²

0+175

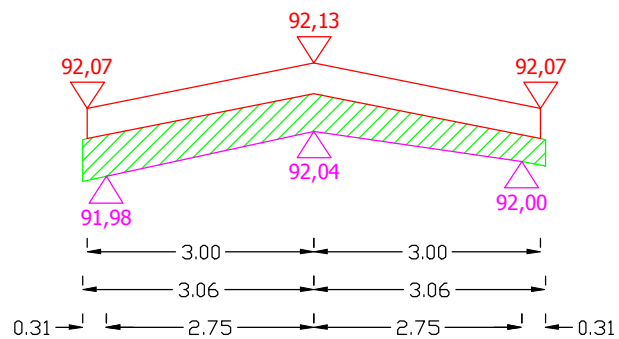

Pwyr.=0,2892 m²

0+185

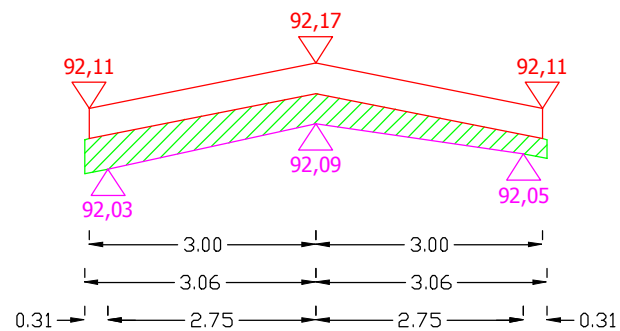

Pwyr.=0,2280 m²

Sporządził:

PRZEKROJE POPRZECZNE DROGI WOJEWÓDZKIEJ NR 651 OD KM 89+925 DO KM 90+332

SKALA 1:10/100

0+195

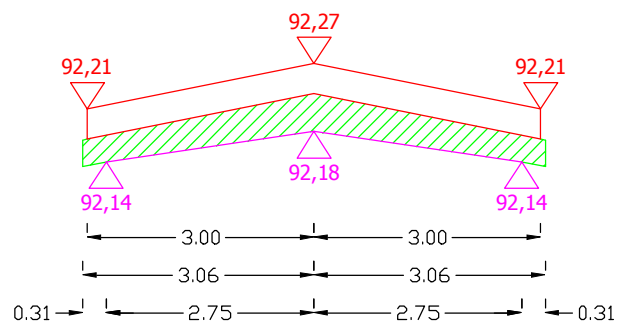

$P_{wyr.} = 0,2555 \text{ m}^2$

0+205

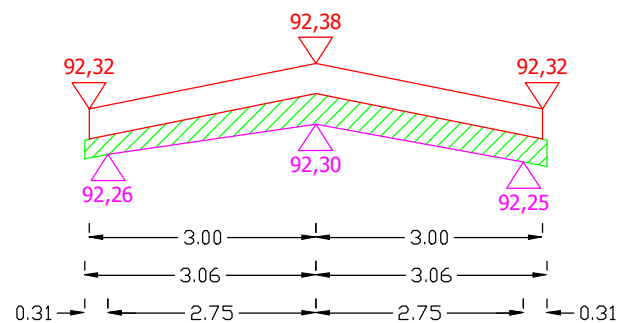

$P_{wyr.} = 0,2111 \text{ m}^2$

0+215

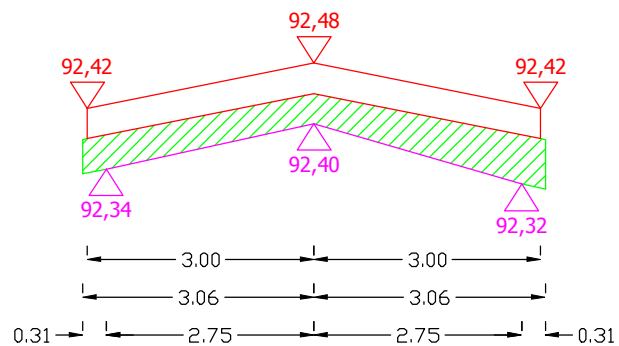

$P_{wyr.} = 0,2954 \text{ m}^2$

0+225,50

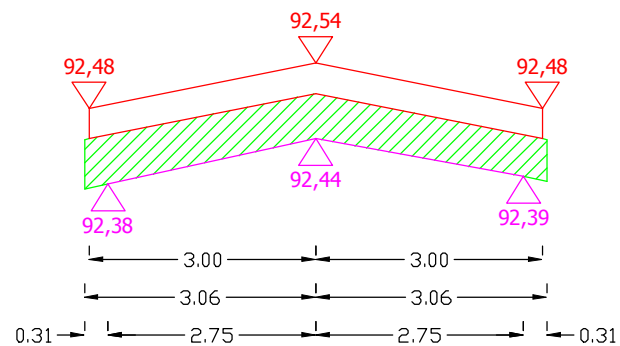

$P_{wyr.} = 0,3672 \text{ m}^2$

Sporządził:

PRZEKROJE POPRZECZNE DROGI WOJEWÓDZKIEJ NR 651 OD KM 89+925 DO KM 90+332

SKALA 1:10/100

0+235

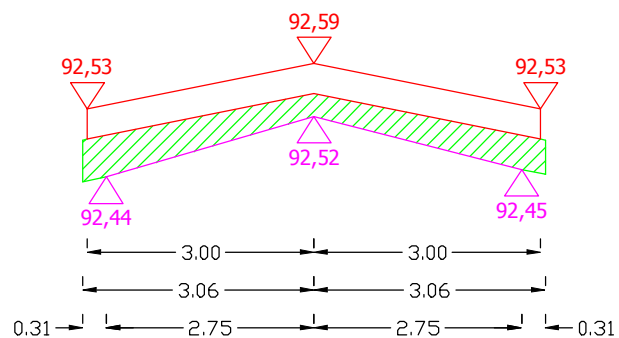

Pwyr.=0,2510 m²

0+245

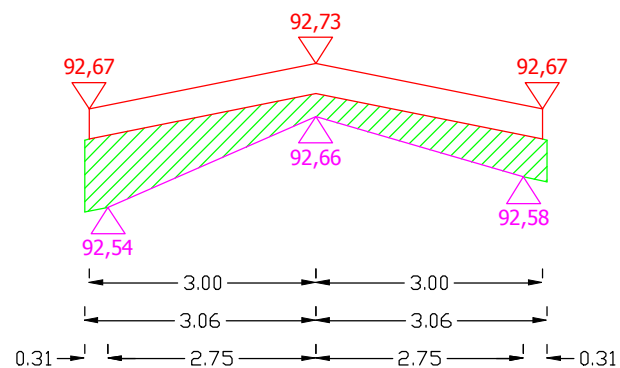

Pwyr.=0,3353 m²

0+255

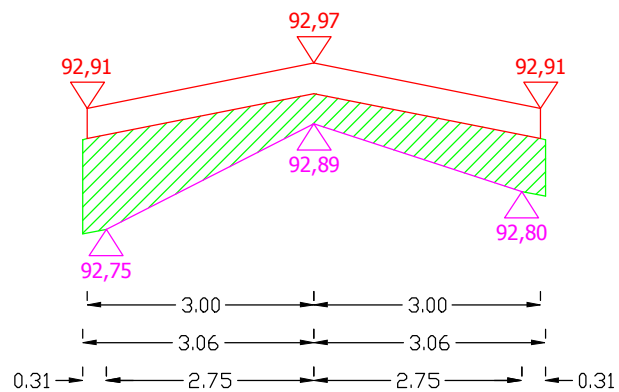

Pwyr.=0,4470 m²

0+265

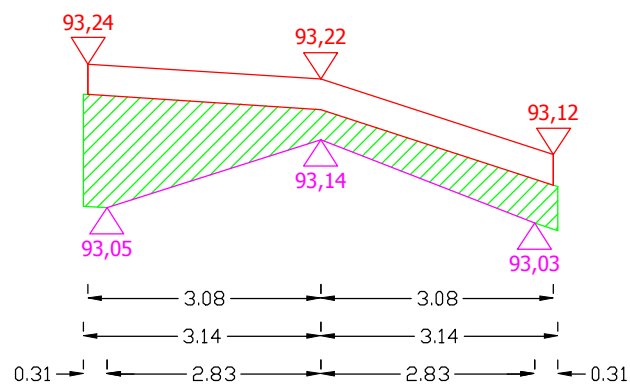

Pwyr.=0,4694 m²

Sporządził:

PRZEKROJE POPRZECZNE DROGI WOJEWÓDZKIEJ NR 651 OD KM 89+925 DO KM 90+332

SKALA 1:10/100

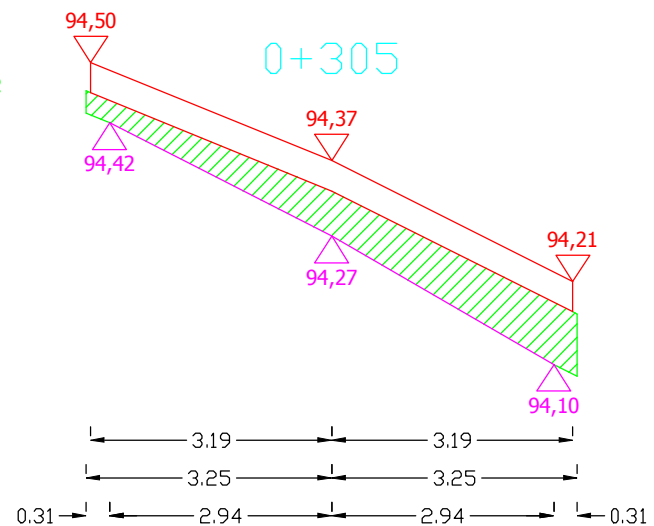
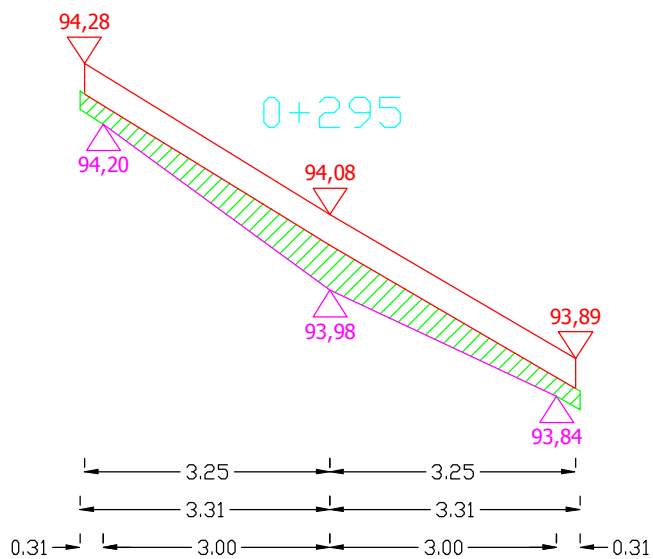
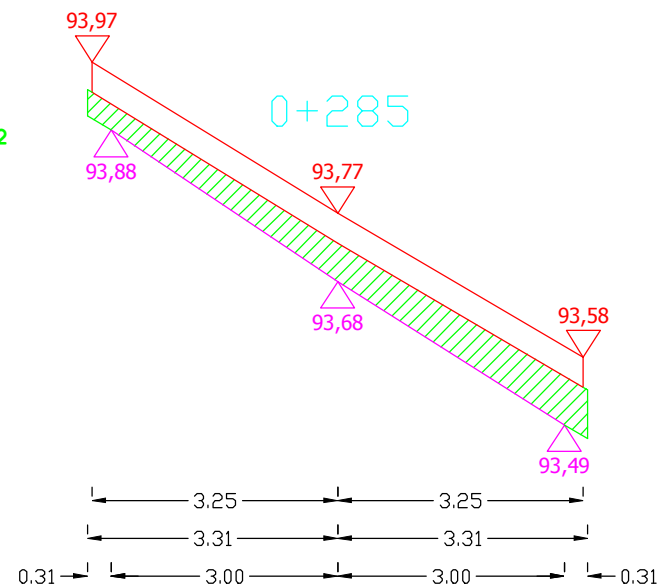
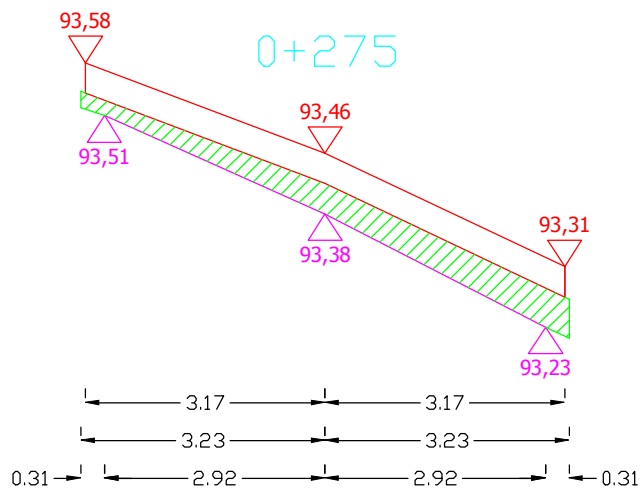

Sporządził:

PRZEKROJE POPRZECZNE DROGI WOJEWÓDZKIEJ NR 651 OD KM 89+925 DO KM 90+332

SKALA 1:10/100

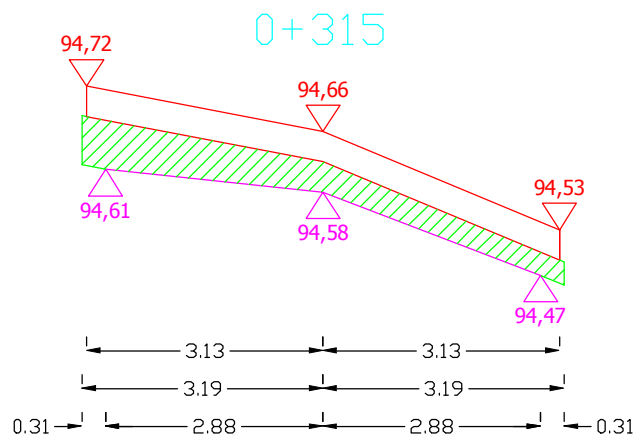

Pwyr.=0,2825 m²

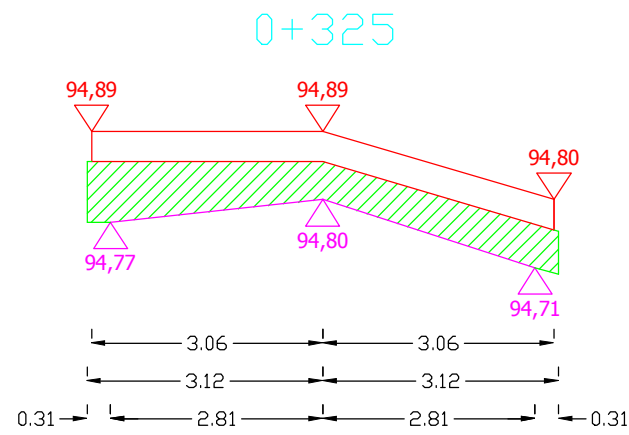

Pwyr.=0,3761 m²

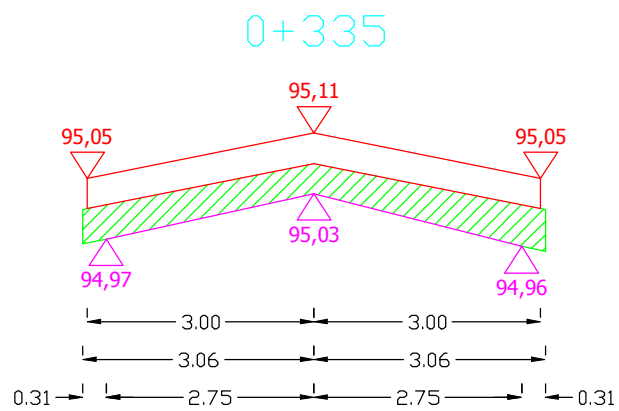

Pwyr.=0,2785 m²

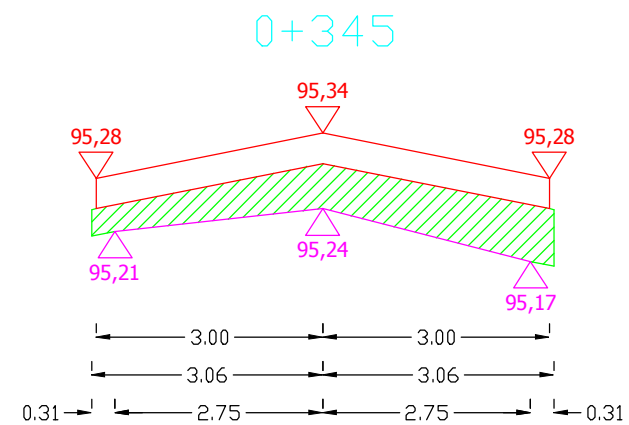

Pwyr.=0,3504 m²

Sporządził:

PRZEKROJE POPRZECZNE DROGI WOJEWÓDZKIEJ NR 651 OD KM 89+925 DO KM 90+332

SKALA 1:10/100

0+355

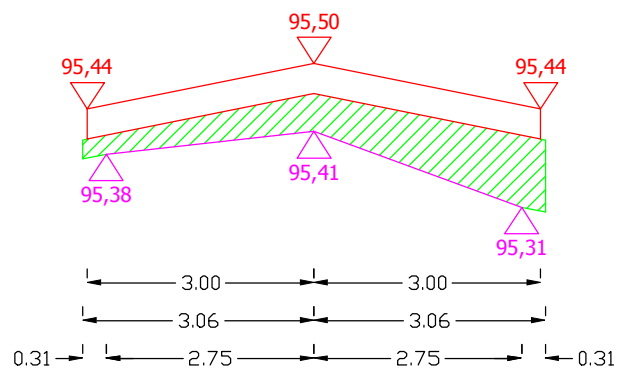

Pwyr.=0,3397 m²

0+365

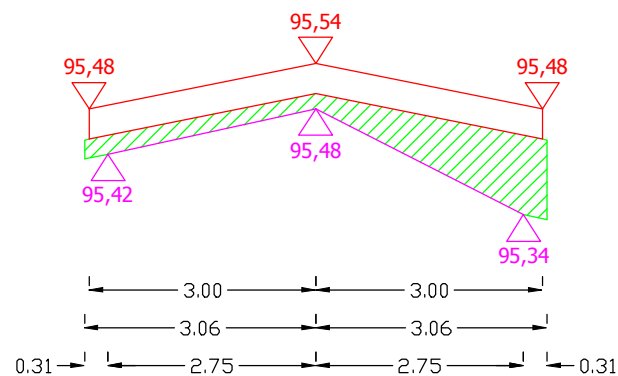

Pwyr.=0,2741 m²

0+375

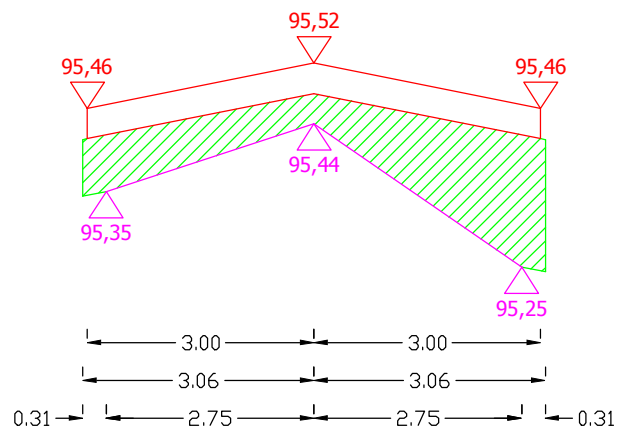

Pwyr.=0,5313 m²

0+385

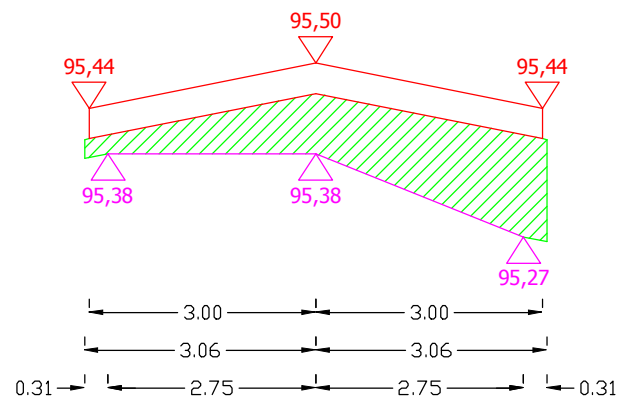

Pwyr.=0,4896 m²

Sporządził:

PRZEKROJE POPRZECZNE DROGI WOJEWÓDZKIEJ NR 651 OD KM 89+925 DO KM 90+332

SKALA 1:10/100

0+395

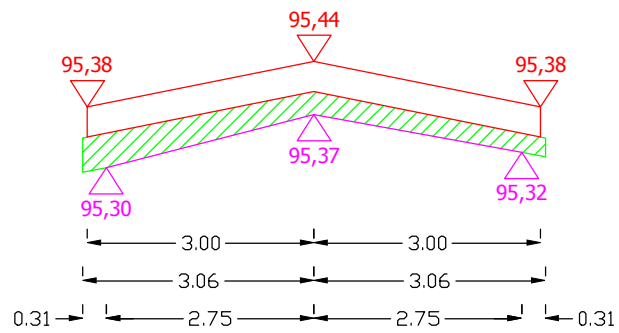

Pwyr.=0,2005 m²

0+407

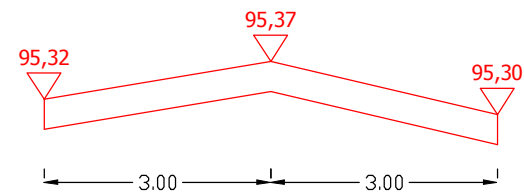

Pwyr.=0,0000 m²